

[See all 3 Products in Family](#)

TECHSPEC® M26/C-Mount Turret



C-Mount Manual Objective Turrets

Stock **#19-534** **5 In Stock**

⊖ 1 ⊕ **S\$1,260⁰⁰**

ADD TO CART

Volume Pricing	
Qty 1-2	S\$1,260.00 each
Qty 3+	S\$1,197.42 each
Need More?	Request Quote

Product Downloads

Threading & Mounting

Thread Type:

C-Mount
Objective: (4) M26 x0.706

Regulatory Compliance

RoHS 2015:

Compliant

Certificate of Conformance:

[View](#)

Product Details

- C-Mount Tube System Compatibility for Creating Modular Microscope System
- Four Objective Positions
- [Mitutoyo](#) and [Nikon](#) Objective Compatibility

C-Mount Manual Objective Turrets are ideal for creating modular microscope systems using standard [C-Mount Tube System Components](#). Edmund Optics' broad range of C-mount Tube System Components offers maximum versatility when designing a microscope system, with direct C-Mount camera compatibility for imaging integration. With additional accessories, these objective turrets can be adapted to [S-Mount](#), [T-Mount](#), [ID1 \(SM1\)](#), and [Multi-Element Tube Systems](#), expanding their potential uses. C-Mount Manual Objective Turrets are offered with M26 x 0.706 threads for [Mitutoyo Objectives](#) and M25 x 0.75 threads for [Nikon Objectives](#). Each turret has four objective positions to maximize imaging system flexibility.

Technical Information

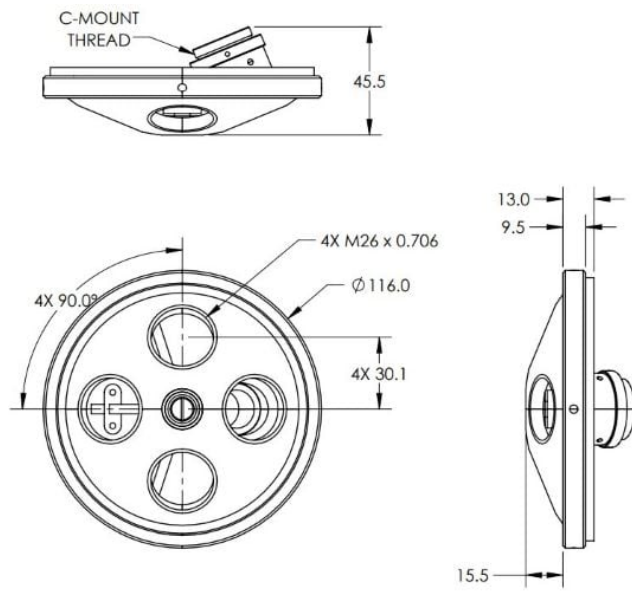

#19-534