

**TECHSPEC® 6mm, f/4 Ci Series Fixed Focal Length Lens**



6mm Focal Length

Stock **#86-594** **20+ In Stock**

⊖ 1 ⊕ **S\$270<sup>00</sup>**

**ADD TO CART**

Volume Pricing

Qty 1-24	<b>S\$270.00</b> each
Qty 25+	<b>S\$243.00</b> each
Need More?	<a href="#">Request Quote</a>

Product Downloads

**General**

Ci Series **Product Family:**

Fixed Focal Length Lens **Type:**

**Physical & Mechanical Properties**

Fixed **Iris Option:**

**Length (mm):**

47.80

34 **Maximum Diameter (mm):**

34 **Outer Diameter (mm):**

64 **Weight (g):**

1.17 **Maximum Rear Protrusion (mm):**

26.50 **Diameter (mm):**

## Optical Properties

**Horizontal Field of View @ Max Sensor Format:**

110.2mm - 62.1°

**Field of View at Max Sensor Format:**

Horizontal: 110mm - 62.1°

Vertical: 80.4mm - 47.8°

Diagonal: 141.9mm - 75°

**Horizontal Field of View, 1/1.8" Sensor:**

110.2mm - 62.1°

**Horizontal Field of View, 1/2" Sensor:**

96.8mm - 55.9°

**Horizontal Field of View, 1/2.5" Sensor:**

86.9mm - 51.0°

**Horizontal Field of View, 1/3" Sensor:**

71.0mm - 42.7°

**Horizontal Field of View, 1/4" Sensor:**

52.6mm - 32.4°

**Maximum Image Circle (mm):**

9.00

**Numerical Aperture NA, Object Side:**

0.0086

**Number of Elements (Groups):**

9 (7)

**Focal Length FL (mm):**

6.00

**Working Distance (mm):**

75 - ∞

**Aperture (f/#):**

f/4

**Coating:**

425 - 675nm BBAR

**Coating Specification:**

425 - 675nm BBAR

**Entrance Pupil Position (mm):**

16.08

**Object Space Principal Plane (mm):**

21.35

**Image Space Principal Plane (mm):**

6.60

**Maximum Distortion (%):**

-6.82

**Exit Pupil Position (mm):**

-25.52

**Lens Wavelength Range:**

VIS

## Sensor

**Maximum Sensor Format:**

1/1.8"

**Pixel Size (µm):**

2.74

## Threading & Mounting

**Filter Thread:**

M43 x 0.75 (Female)

**Filter Thread Adapter:**

[#89-940 \(Required\)](#)

**Front Thread:**

M34.0 x 0.5 (Male)

**Mount:**

C-Mount

## Environmental & Durability Factors

Storage Temperature (°C):

-20 to +60

Type of Ruggedization:

Industrial (Fixed Aperture with Simplified Mechanics)

## Regulatory Compliance

Compliant

RoHS 2015:

Compliant

REACH 201:

View

Certificate of Conformance:

## Product Details

These compact lenses are designed specifically for volume integration into applications such as analytical medical devices, including benchtop-based blood analyzers. For customized  $f\#$  versions to best suit your instrumentation application needs and to discuss volume requirements, please [contact us](#).

- Up to 2/3", C-Mount Lens
- Up to 7.5 MegaPixels, 2.8 $\mu$ m Pixel Size Sensors
- Instrumentation (Ci) Versions of our C Series Lenses with Streamlined Mechanical Designs and Fixed Apertures
- 3.5mm to 50mm Focal Length
- **Ruggedized (Cr) Designs** Also Available

TECHSPEC® Ci Series Fixed Focal Length Lenses are a streamlined version of our C Series Fixed Focal Length Lenses. They feature the same low lens-to-lens variation and broadband anti-reflection (BBAR) coating for maximum light transmission, while offering reduced weight and size. An adjustable, lockable focus allows for setting and locking the best focus position for instrumentation integration. TECHSPEC® Ci Series Fixed Focal Length Lenses are designed specifically for volume integration into applications such as factory inspection and automation to benchtop biomedical devices. The Ci Series offers a wide range of aperture options, ensuring maximum flexibility of resolution, throughput, and depth of field.

Edmund Optics has created a family of high performance optical designs (the C Series family) and developed 6 customized optomechanical solutions targeted for specific applications. These lens sub-families utilize the same optics as the C Series lenses providing the same optical performance in a variety of optomechanical solutions to meet your application requirements:

- **C Series:** Features locking cam focus and iris adjustment and is the most adjustable version of these optical designs; they are the typical high quality machine vision lenses. Also available with a **VIS-NIR Broadband Anti-Reflection (BBAR) Coating**.
- **Ci Series:** Simplified mechanics featuring fixed apertures with compact housing. **Industrial Ruggedization** for reduced size, cost, and locked focus.
- **Cr Series:** All optics glued in place and a locking C-clamp focus ring. **Stabilized Ruggedization** for reduced pixel shift and improved focus stability.
- **Cx Series:** Modular, flexible mechanics allows lenses to be taken apart for easy integration of accessories such as liquid lenses, apertures, and more.
- **Liquid Lens Cx Series:** Designed with an integrated liquid lens for quick autofocus.
- **Cw Series:** Waterproof, designed to meet IEC **Ingress Protection** Code IPX7 and IPX9K.

## Technical Information

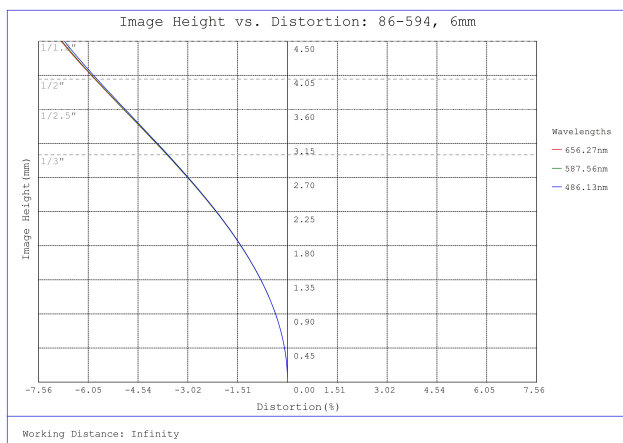

#86-594, 6mm, f/4 Ci Series Fixed Focal Length Lens, Distortion Plot

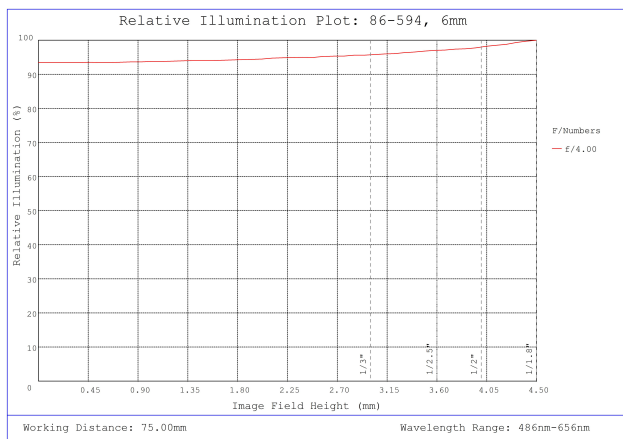

#86-594, 6mm, f/4 Ci Series Fixed Focal Length Lens, Relative Illumination Plot

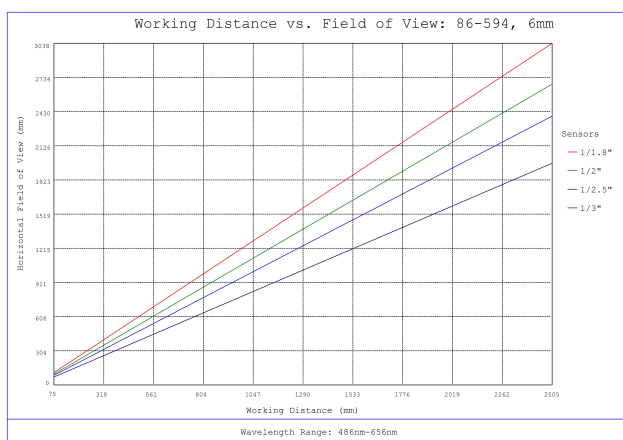

#86-594, 6mm, f/4 Ci Series Fixed Focal Length Lens, Working Distance versus Field of View Plot

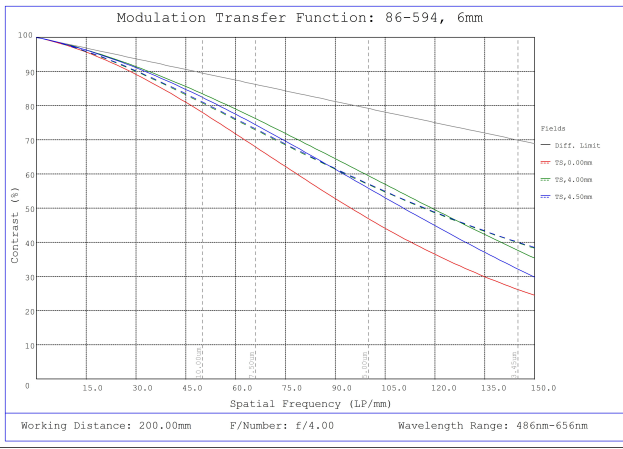

#86-594, 6mm, f/4 Ci Series Fixed Focal Length Lens, Modulated Transfer Function (MTF) Plot, 200mm Working Distance, f4

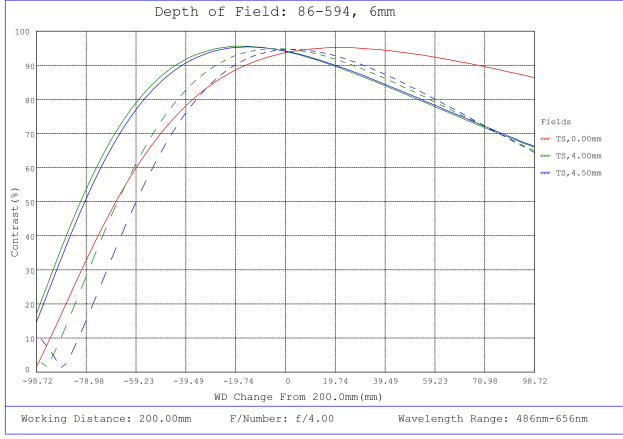

#86-594, 6mm, f/4 Ci Series Fixed Focal Length Lens, Depth of Field Plot, 200mm Working Distance, f4

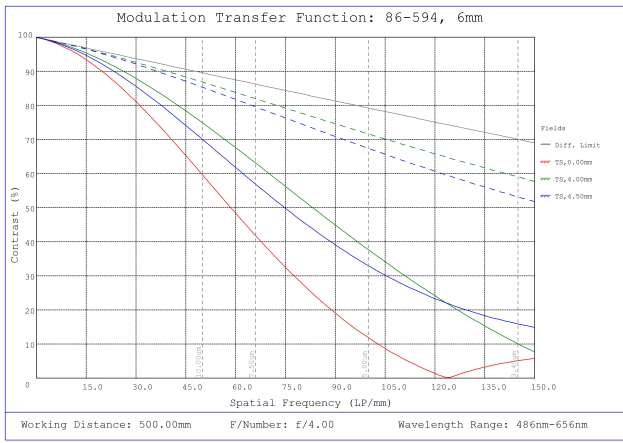

#86-594, 6mm, f/4 Ci Series Fixed Focal Length Lens, Modulated Transfer Function (MTF) Plot, 500mm Working Distance, f4

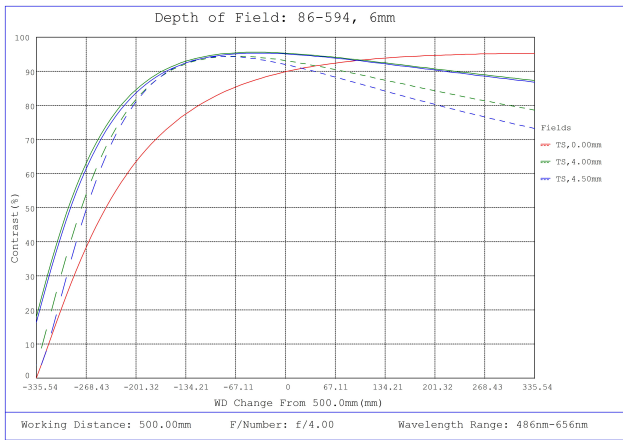

#86-594, 6mm, f/4 Ci Series Fixed Focal Length Lens, Depth of Field Plot, 500mm Working Distance, f4

Focal Length	A	B	C	D
6mm	M34.0 x 0.5	47.8mm	34mm	1.17mm
12mm	M22.0 x 0.75	29.0mm	22mm	0.96mm
16mm	M22.0 x 0.75	40.8mm	22mm	1.09mm
25mm	M22.0 x 0.75	29.9mm	22mm	1.33mm
35mm	M25.5 x 0.5	41mm	22.5mm	3.82mm
50mm	M30.5 x 0.5	49.5mm	30.5mm	2.06mm

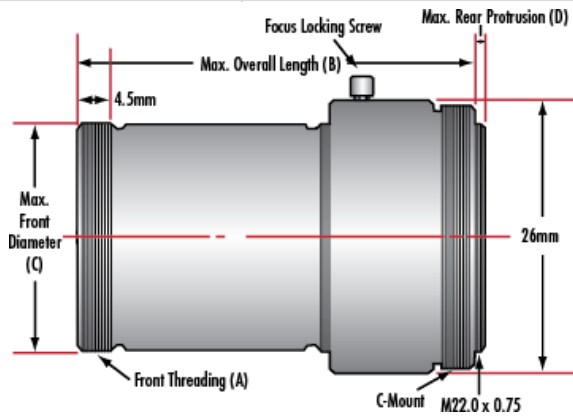

## Compatible Cameras

---