

**TECHSPEC® 3.5mm, f/5.6 Ci Series Fixed Focal Length Lens**



3.5mm Focal Length

Stock **#87-548** **1 In Stock**

⊖ 1 ⊕ **S\$332.00**

**ADD TO CART**

Volume Pricing	
Qty 1-24	<b>S\$332.00</b> each
Qty 25+	<b>S\$299.00</b> each
Need More?	<a href="#">Request Quote</a>

Product Downloads

**General**

Ci Series **Product Family:**  
Fixed Focal Length Lens **Type:**

**Physical & Mechanical Properties**

Fixed **Iris Option:**  
**Length (mm):**

39.38

50 **Maximum Diameter (mm):**

50 **Outer Diameter (mm):**

97 **Weight (g):**

2.64 **Maximum Rear Protrusion (mm):**

26.50 **Diameter (mm):**

## Optical Properties

**Horizontal Field of View @ Max Sensor Format:**

41.2mm - 102.8°

**Field of View at Max Sensor Format:**

Horizontal: 41.2mm - 102.3°

Vertical: 26.8mm - 82.3°

Diagonal: 63.5mm - 117°

**Horizontal Field of View, 1/1.8" Sensor:**

41.2mm - 102.8°

**Horizontal Field of View, 1/2" Sensor:**

29.5mm - 87.2°

**Horizontal Field of View, 1/3" Sensor:**

23.0mm - 74.4°

**Horizontal Field of View, 1/4" Sensor:**

16.3mm - 57.4°

**Maximum Image Circle (mm):**

9.00

**Numerical Aperture NA, Object Side:**

0.0205

**Number of Elements (Groups):**

8 (7)

**Focal Length FL (mm):**

3.50

**Working Distance (mm):**

0 - ∞

**Aperture (f/#):**

f/5.6

**Coating:**

425 - 675nm BBAR

**Coating Specification:**

425 - 675nm BBAR

**Entrance Pupil Position (mm):**

15.27

**Object Space Principal Plane (mm):**

18.31

**Image Space Principal Plane (mm):**

7.49

**Maximum Distortion (%):**

-20.94

**Exit Pupil Position (mm):**

-15.28

**Lens Wavelength Range:**

VIS

## Sensor

**Maximum Sensor Format:**

1/1.8"

**Pixel Size (µm):**

2.74

## Threading & Mounting

**Filter Thread:**

M105 x 1.00 (Male)

**Filter Thread Adapter:**

[#89-848 \(Required\)](#)

**Front Thread:**

M50.0 x 0.5 (Male)

**Mount:**

C-Mount

## Environmental & Durability Factors

**Storage Temperature (°C):**

-20 to +60

## Regulatory Compliance

Certificate of Conformance:

[View](#)

## Product Details

- Up to 2/3", C-Mount Lens
- Up to 7.5 MegaPixels, 2.8µm Pixel Size Sensors
- Instrumentation (Ci) Versions of our C Series Lenses with Streamlined Mechanical Designs and Fixed Apertures
- 3.5mm to 50mm Focal Length
- [Ruggedized \(Cr\) Designs](#) Also Available

TECHSPEC® Ci Series Fixed Focal Length Lenses are a streamlined version of our C Series Fixed Focal Length Lenses. They feature the same low lens-to-lens variation and broadband anti-reflection (BBAR) coating for maximum light transmission, while offering reduced weight and size. An adjustable, lockable focus allows for setting and locking the best focus position for instrumentation integration. TECHSPEC® Ci Series Fixed Focal Length Lenses are designed specifically for volume integration into applications such as factory inspection and automation to benchtop biomedical devices. The Ci Series offers a wide range of aperture options, ensuring maximum flexibility of resolution, throughput, and depth of field.

Edmund Optics has created a family of high performance optical designs (the C Series family) and developed 6 customized optomechanical solutions targeted for specific applications. These lens sub-families utilize the same optics as the C Series lenses providing the same optical performance in a variety of optomechanical solutions to meet your application requirements:

- **C Series:** Features locking cam focus and iris adjustment and is the most adjustable version of these optical designs; they are the typical high quality machine vision lenses. Also available with a [VIS-NIR Broadband Anti-Reflection \(BBAR\) Coating](#).
- **Ci Series:** Simplified mechanics featuring fixed apertures with compact housing. [Industrial Ruggedization](#) for reduced size, cost, and locked focus.
- **Cr Series:** All optics glued in place and a locking C-clamp focus ring. [Stabilized Ruggedization](#) for reduced pixel shift and improved focus stability.
- **Cx Series:** Modular, flexible mechanics allows lenses to be taken apart for easy integration of accessories such as liquid lenses, apertures, and more.
- **Liquid Lens Cx Series:** Designed with an integrated liquid lens for quick autofocus.
- **Cw Series:** Waterproof, designed to meet IEC [Ingress Protection](#) Code IPX7 and IPX9K.

## Technical Information



#87-548, 3.5mm, f/5.6 Ci Series Fixed Focal Length Lens, Distortion Plot

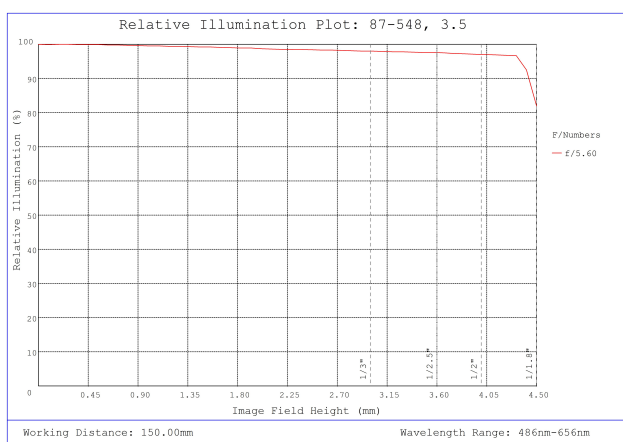

#87-548, 3.5mm, f/5.6 Ci Series Fixed Focal Length Lens, Relative Illumination Plot

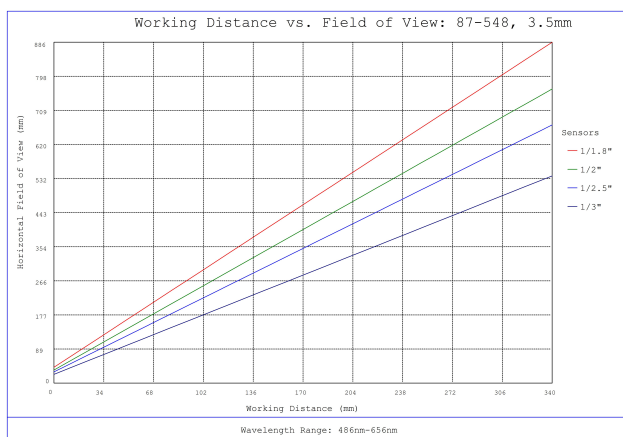

#87-548, 3.5mm, f/5.6 Ci Series Fixed Focal Length Lens, Working Distance versus Field of View Plot

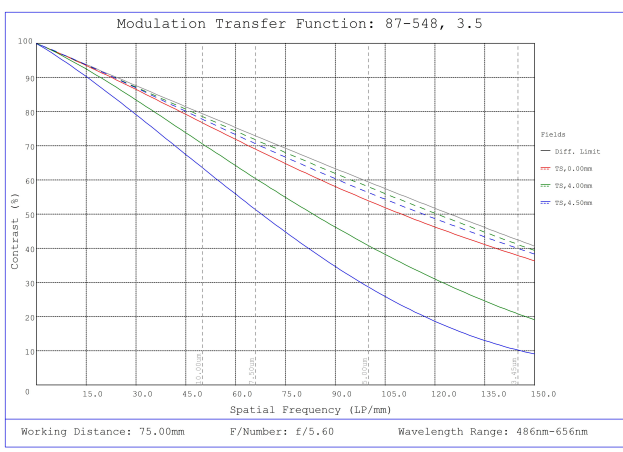

#87-548, 3.5mm, f/5.6 Ci Series Fixed Focal Length Lens, Modulated Transfer Function (MTF) Plot, 75mm Working Distance, f5.6

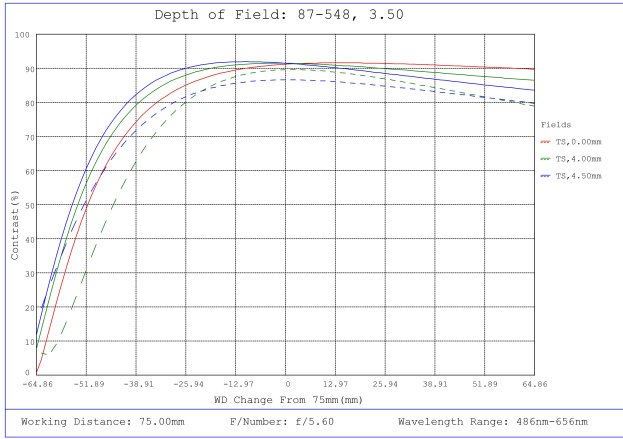

#87-548, 3.5mm, f/5.6 Ci Series Fixed Focal Length Lens, Depth of Field Plot, 75mm Working Distance, f5.6

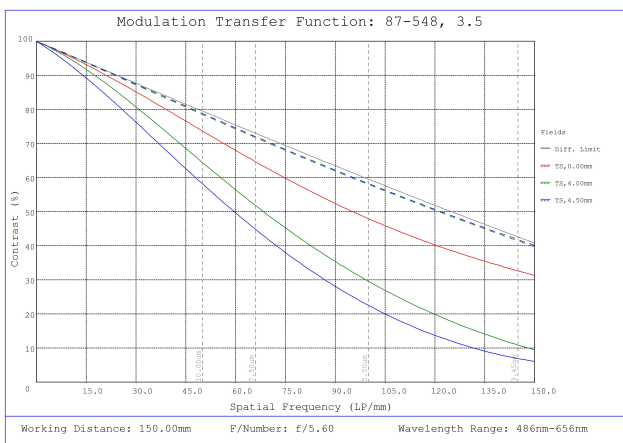

#87-548, 3.5mm, f/5.6 Ci Series Fixed Focal Length Lens, Modulated Transfer Function (MTF) Plot, 150mm Working Distance, f5.6

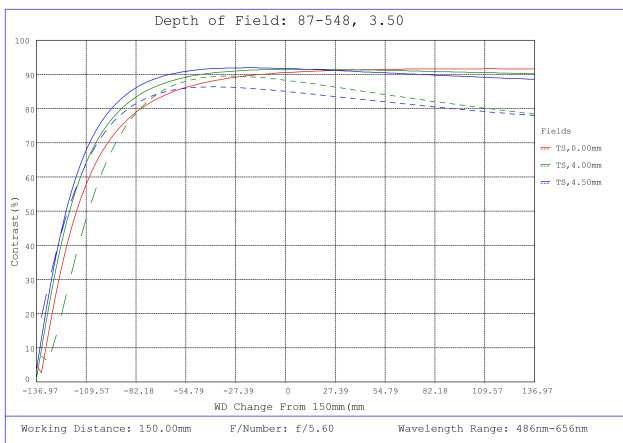

#87-548, 3.5mm, f/5.6 Ci Series Fixed Focal Length Lens, Depth of Field Plot, 150mm Working Distance, f5.6

Focal Length	A	B	C	D
6mm	M34.0 x 0.5	47.8mm	34mm	1.17mm
12mm	M22.0 x 0.75	29.0mm	22mm	0.96mm
16mm	M22.0 x 0.75	40.8mm	22mm	1.09mm
25mm	M22.0 x 0.75	29.9mm	22mm	1.33mm
35mm	M25.5 x 0.5	41mm	22.5mm	3.82mm
50mm	M30.5 x 0.5	49.5mm	30.5mm	2.06mm

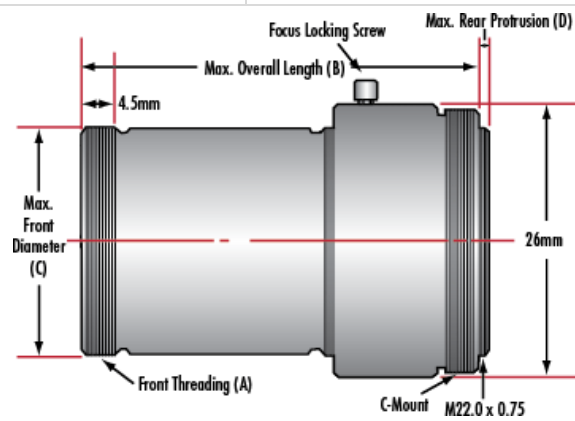

## Compatible Cameras

---

;