

**TECHSPEC® 3.5mm, f/11 Ci Series Fixed Focal Length Lens**



3.5mm Focal Length

Stock **#87-550** **5 In Stock**

- 1 + **S\$332<sup>00</sup>**

**ADD TO CART**

Volume Pricing	
Qty 1-24	<b>S\$332.00</b> each
Qty 25+	<b>S\$299.00</b> each
Need More?	<a href="#">Request Quote</a>

Product Downloads

**General**

Ci Series **Product Family:**  
Fixed Focal Length Lens **Type:**

**Physical & Mechanical Properties**

Fixed **Iris Option:**  
**Length (mm):**

39.38

Maximum Diameter (mm):

50

Outer Diameter (mm):

50

Weight (g):

97

Maximum Rear Protrusion (mm):

2.64

Diameter (mm):

26.50

## Optical Properties

Horizontal Field of View @ Max Sensor Format:

41.2mm - 102.8°

Field of View at Max Sensor Format:

Horizontal: 41.2mm - 102.3°

Vertical: 26.8mm - 82.3°

Diagonal: 63.5mm - 116.9°

Horizontal Field of View, 1/1.8" Sensor:

41.2mm - 102.8°

Horizontal Field of View, 1/2" Sensor:

29.5mm - 87.2°

Horizontal Field of View, 1/3" Sensor:

23.0mm - 74.4°

Horizontal Field of View, 1/4" Sensor:

16.3mm - 57.4°

Maximum Image Circle (mm):

9.00

Numerical Aperture NA, Object Side:

0.0104

Number of Elements (Groups):

8 (7)

Focal Length FL (mm):

3.50

Working Distance (mm):

0 - ∞

Aperture (f/#):

f/11

Coating:

425 - 675nm BBAR

Coating Specification:

425 - 675nm BBAR

Entrance Pupil Position (mm):

15.27

Object Space Principal Plane (mm):

18.31

Image Space Principal Plane (mm):

7.49

Maximum Distortion (%):

-20.94

Exit Pupil Position (mm):

-15.28

Lens Wavelength Range:

VIS

## Sensor

Maximum Sensor Format:

1/1.8"

Pixel Size (µm):

2.74

## Threading & Mounting

Filter Thread:

M105 x 1.00 (Male)

Filter Thread Adapter:

[#89-848 \(Required\)](#)

Front Thread:

M50.0 x 0.5 (Male)

Mount:

C-Mount

## Environmental & Durability Factors

Storage Temperature (°C):

**Type of Ruggedization:**

Industrial (Fixed Aperture with Simplified Mechanics)

## Regulatory Compliance

Certificate of Conformance:

[View](#)

## Product Details

- Up to 2/3", C-Mount Lens
- Up to 7.5 MegaPixels, 2.8µm Pixel Size Sensors
- Instrumentation (Ci) Versions of our C Series Lenses with Streamlined Mechanical Designs and Fixed Apertures
- 3.5mm to 50mm Focal Length
- **Ruggedized (Cr) Designs** Also Available

TECHSPEC® Ci Series Fixed Focal Length Lenses are a streamlined version of our C Series Fixed Focal Length Lenses. They feature the same low lens-to-lens variation and broadband anti-reflection (BBAR) coating for maximum light transmission, while offering reduced weight and size. An adjustable, lockable focus allows for setting and locking the best focus position for instrumentation integration. TECHSPEC® Ci Series Fixed Focal Length Lenses are designed specifically for volume integration into applications such as factory inspection and automation to benchtop biomedical devices. The Ci Series offers a wide range of aperture options, ensuring maximum flexibility of resolution, throughput, and depth of field.

Edmund Optics has created a family of high performance optical designs (the C Series family) and developed 6 customized optomechanical solutions targeted for specific applications. These lens sub-families utilize the same optics as the C Series lenses providing the same optical performance in a variety of optomechanical solutions to meet your application requirements:

- **C Series:** Features locking cam focus and iris adjustment and is the most adjustable version of these optical designs; they are the typical high quality machine vision lenses. Also available with a **VIS-NIR Broadband Anti-Reflection (BBAR) Coating**.
- **Ci Series:** Simplified mechanics featuring fixed apertures with compact housing. **Industrial Ruggedization** for reduced size, cost, and locked focus.
- **Cr Series:** All optics glued in place and a locking C-clamp focus ring. **Stabilized Ruggedization** for reduced pixel shift and improved focus stability.
- **Cx Series:** Modular, flexible mechanics allows lenses to be taken apart for easy integration of accessories such as liquid lenses, apertures, and more.
- **Liquid Lens Cx Series:** Designed with an integrated liquid lens for quick autofocus.
- **Cw Series:** Waterproof, designed to meet IEC **Ingress Protection** Code IPX7 and IPX9K.

## Technical Information

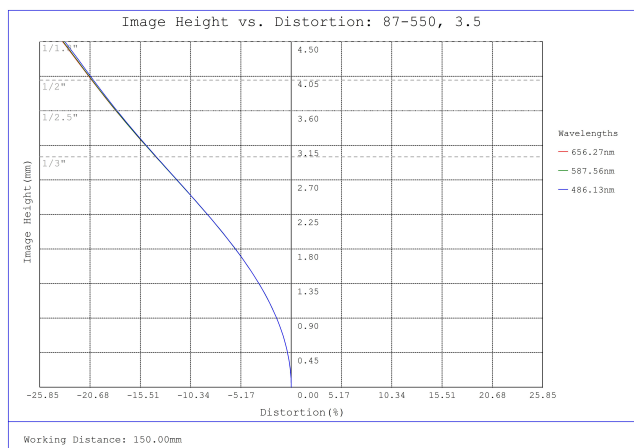

#87-550, 3.5mm, f/11 Ci Series Fixed Focal Length Lens, Distortion Plot

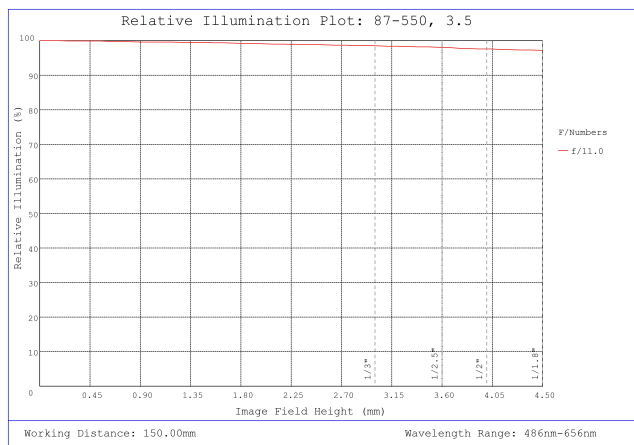

#87-550, 3.5mm, f/11 Ci Series Fixed Focal Length Lens, Relative Illumination Plot

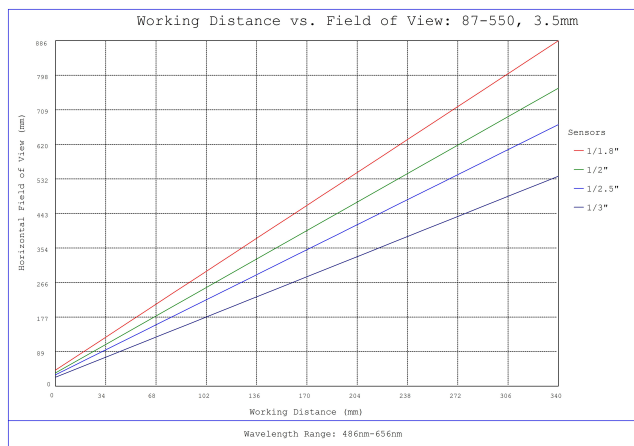

#87-550, 3.5mm, f/11 Ci Series Fixed Focal Length Lens, Working Distance versus Field of View Plot

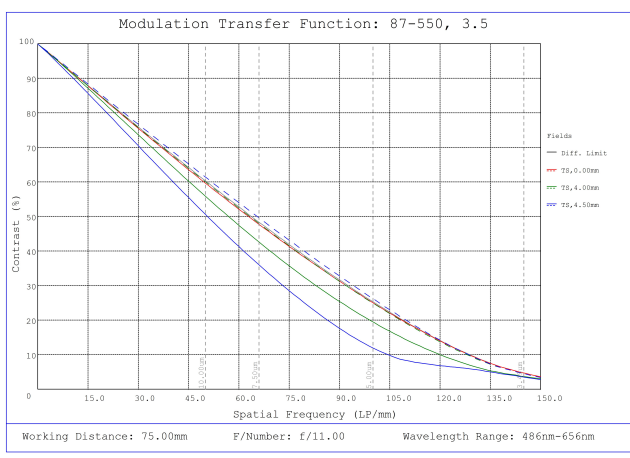

#87-550, 3.5mm, f/11 Ci Series Fixed Focal Length Lens, Modulated Transfer Function (MTF) Plot, 75mm Working Distance, f11

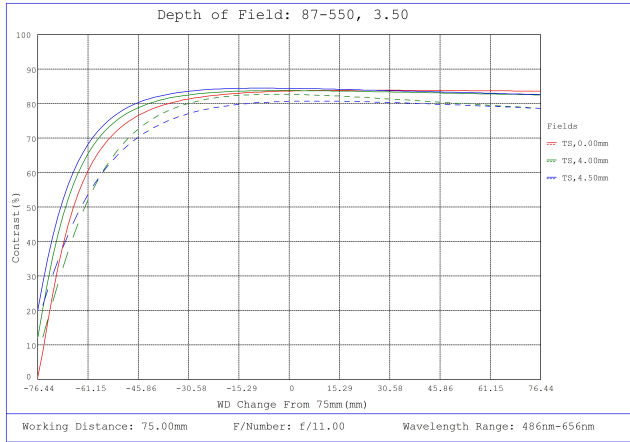

#87-550, 3.5mm, f/11 Ci Series Fixed Focal Length Lens, Depth of Field Plot, 75mm Working Distance, f11

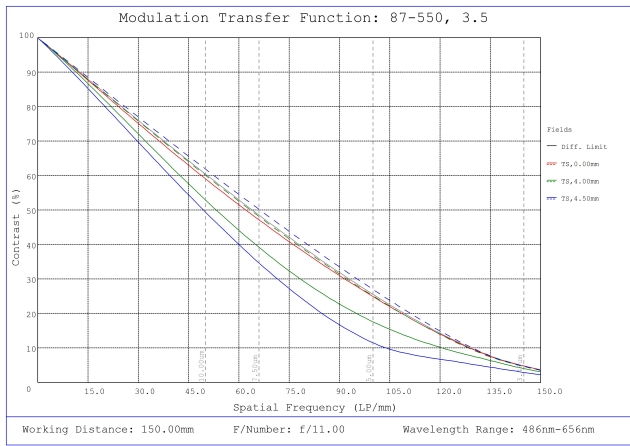

#87-550, 3.5mm, f/11 Ci Series Fixed Focal Length Lens, Modulated Transfer Function (MTF) Plot, 150mm Working Distance, f11

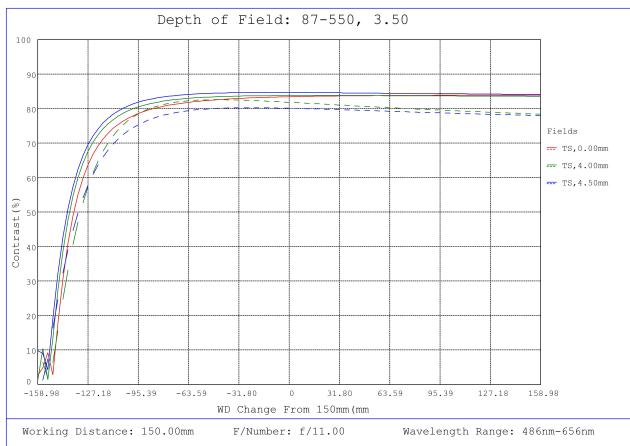

#87-550, 3.5mm, f/11 Ci Series Fixed Focal Length Lens, Depth of Field Plot, 150mm Working Distance, f11

Focal Length	A	B	C	D
6mm	M34.0 x 0.5	47.8mm	34mm	1.17mm
12mm	M22.0 x 0.75	29.0mm	22mm	0.96mm
16mm	M22.0 x 0.75	40.8mm	22mm	1.09mm
25mm	M22.0 x 0.75	29.9mm	22mm	1.33mm
35mm	M25.5 x 0.5	41mm	22.5mm	3.82mm
50mm	M30.5 x 0.5	49.5mm	30.5mm	2.06mm

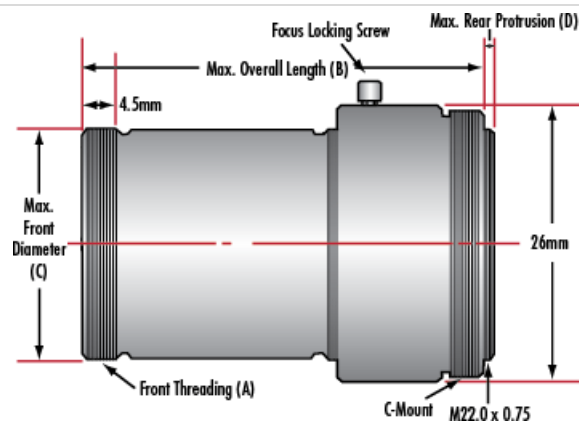

## Compatible Cameras

;