

[See all 10 Products in Family](#)

TECHSPEC® 16mm LT Series Fixed Focal Length Lens



16mm FL Front, #14-362



Stock **#14-362** CLEARANCE **12 In Stock**

S\$1,729⁰⁰

ADD TO CART

Volume Pricing	
Qty 1+	S\$1,729.00 each
Need More?	Request Quote

Note: This item requires accessories for use | [Learn More](#)

Product Downloads

General

LT Series **Product Family:**

Diameter includes liquid lens **Note:**

Fixed Focal Length Lens **Type:**

Integrated Liquid Lens Model:
Optutune EL-10-30-TC-VIS-5D

Imaging Lens Type:
Integrated Liquid Lens to Adjust Focus Electronically

Special Type of Lens:
Liquid Lens Focusable

Physical & Mechanical Properties

Iris Option:
Fixed

Length (mm):
82.10

Maximum Diameter (mm):
89.5

Outer Diameter (mm):
89.5

Weight (g):
323.0

Maximum Rear Protrusion (mm):
0

Optical Properties

Horizontal Field of View @ Max Sensor Format:
165.5mm - 49.1°

Field of View at Max Sensor Format:
Horizontal: 166.6mm - 48.5°
Vertical: 122mm - 36.7°
Diagonal: 216.2mm - 60.2°

Horizontal Field of View, 1.1" Sensor:
165.5mm - 49.1°

Horizontal Field of View, 1" Sensor:
147.6mm - 44.4°

Horizontal Field of View, 2/3" Sensor:
99.1mm - 30.8°

Horizontal Field of View, 1/1.8" Sensor:
80.6mm - 25.3°

Horizontal Field of View, 1/2" Sensor:
71.4mm - 22.5°

Horizontal Field of View, 1/2.5" Sensor:
64.6mm - 20.4°

Horizontal Field of View, 1/3" Sensor:
53.3mm - 16.9°

Horizontal Field of View, 1/4" Sensor:
39.9mm - 12.7°

Maximum Image Circle (mm):
17.60

Numerical Aperture NA, Object Side:
0.0159

Number of Elements (Groups):
9 (6)

Focal Length FL (mm):
16.00

Working Distance (mm):
150 - ∞

Aperture (f#):
f/2.8

Coating:
M4 MgF₂

Coating Specification:
M4 MgF₂

Entrance Pupil Position (mm):
30.45

Object Space Principal Plane (mm):
44.38

Image Space Principal Plane (mm):
7.72

Maximum Distortion (%):
-6.77

Exit Pupil Position (mm):
-101.37

Lens Wavelength Range:
VIS

Sensor

1.1" **Maximum Sensor Format:**

2.74 **Pixel Size (µm):**

Threading & Mounting

M55.0 x 0.75 (Female) **Filter Thread:**

C-Mount **Mount:**

Environmental & Durability Factors

-20 to +60 **Storage Temperature (°C):**

Regulatory Compliance

[View](#) **Certificate of Conformance:**

Product Details

- 1.1" Sensor, C-Mount Lens, up to 12 MegaPixels, 3.45µm Pixel Size Sensor
- Integrated Liquid Lens Allows for Dynamic Autofocus
- Liquid Tunable (LT) Lens Maximizes the Liquid Lens Capabilities for Resolution, Range and Focus Speed
- 12 to 25mm Focal Length

TECHSPEC® LT Series Fixed Focal Length Lenses feature a high-resolution f/2.8 optical design with an integrated Optotune liquid lens for fast electronic focus. The increased light throughput f/2.8 aperture is ideal for high-speed machine vision applications. When combined with an appropriate camera and software, the focus tunable liquid lens provides the active focus control needed to achieve an autofocus solution. These C-Mount lenses are optimized for 1.1" sensors and have front filter threading to integrate imaging filters to meet application requirements. TECHSPEC® LT Series Fixed Focal Length Lenses are ideal for machine vision and factory automation applications where focusing at multiple distances is required, such as quality inspection systems, rapid automation, and package sorting. The TECHSPEC® LT Series Fixed Focal Length Lenses won the [Gold-Level 2021 Vision Systems Design Innovators Award](#) and [third place 2021 reader's choice inspect Award](#).



inspect
award 2021
winner

Note: Hirose cables (2 length options) and Lens Driver are required for operation and sold separately.

Technical Information

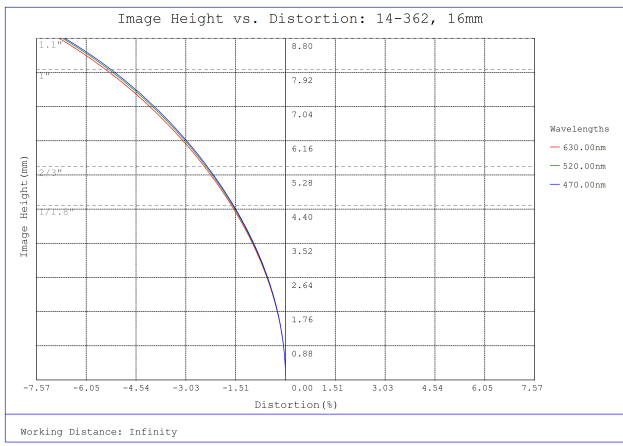

#14-362, 16mm LT Series Fixed Focal Length Lens, Distortion Plot

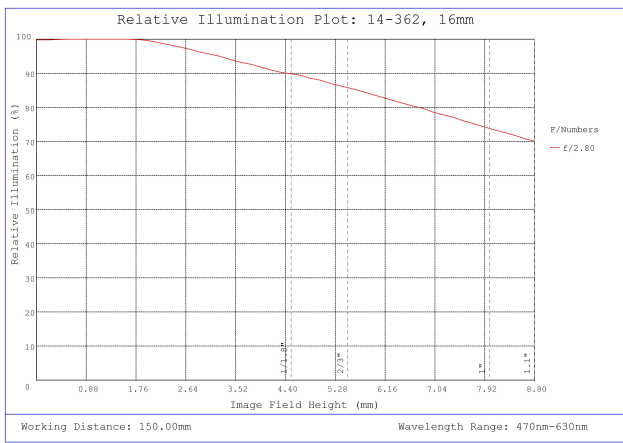

#14-362, 16mm LT Series Fixed Focal Length Lens, Relative Illumination Plot

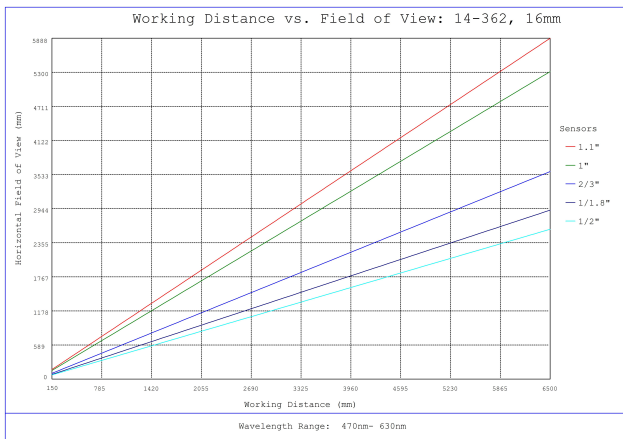

#14-362, 16mm LT Series Fixed Focal Length Lens, Working Distance versus Field of View Plot

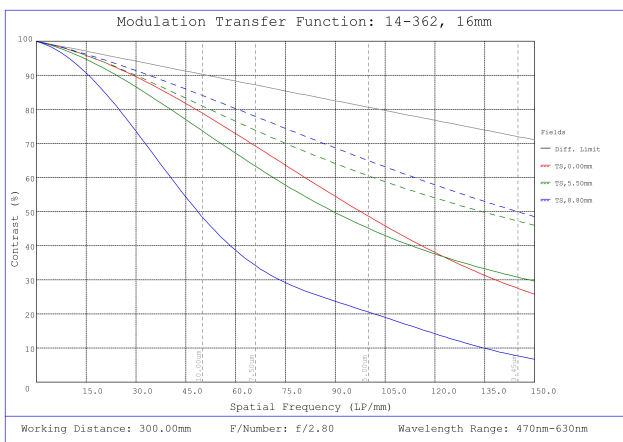

#14-362, 16mm LT Series Fixed Focal Length Lens, Modulated Transfer Function (MTF) Plot, 300mm Working Distance, f2.8

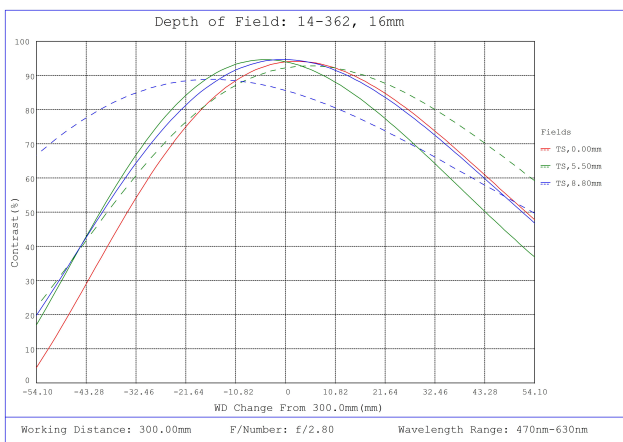

#14-362, 16mm LT Series Fixed Focal Length Lens, Depth of Field Plot, 300mm Working Distance, f2.8

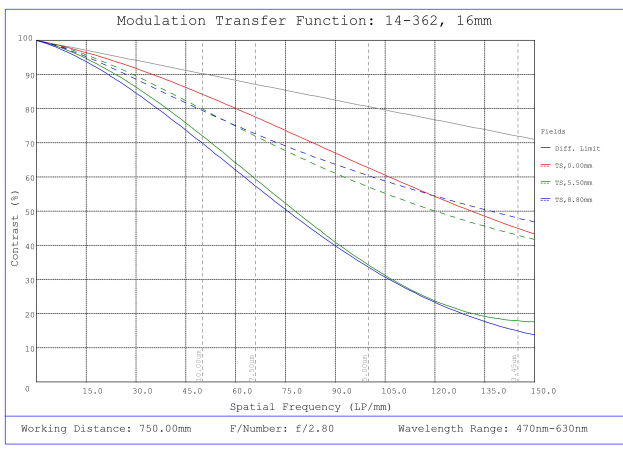

#14-362, 16mm LT Series Fixed Focal Length Lens, Modulated Transfer Function (MTF) Plot, 750mm Working Distance, f2.8

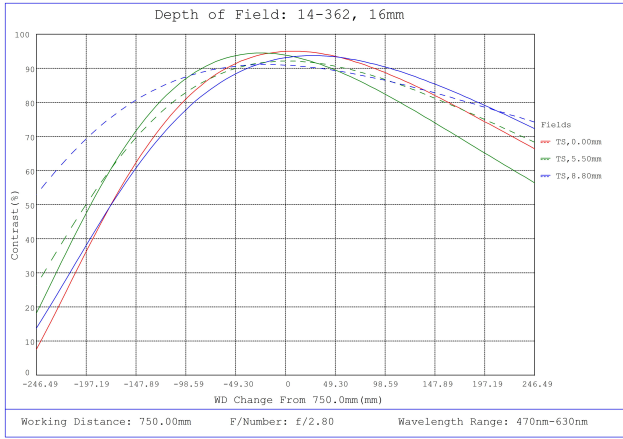

#14-362, 16mm LT Series Fixed Focal Length Lens, Depth of Field Plot, 750mm Working Distance, f2.8

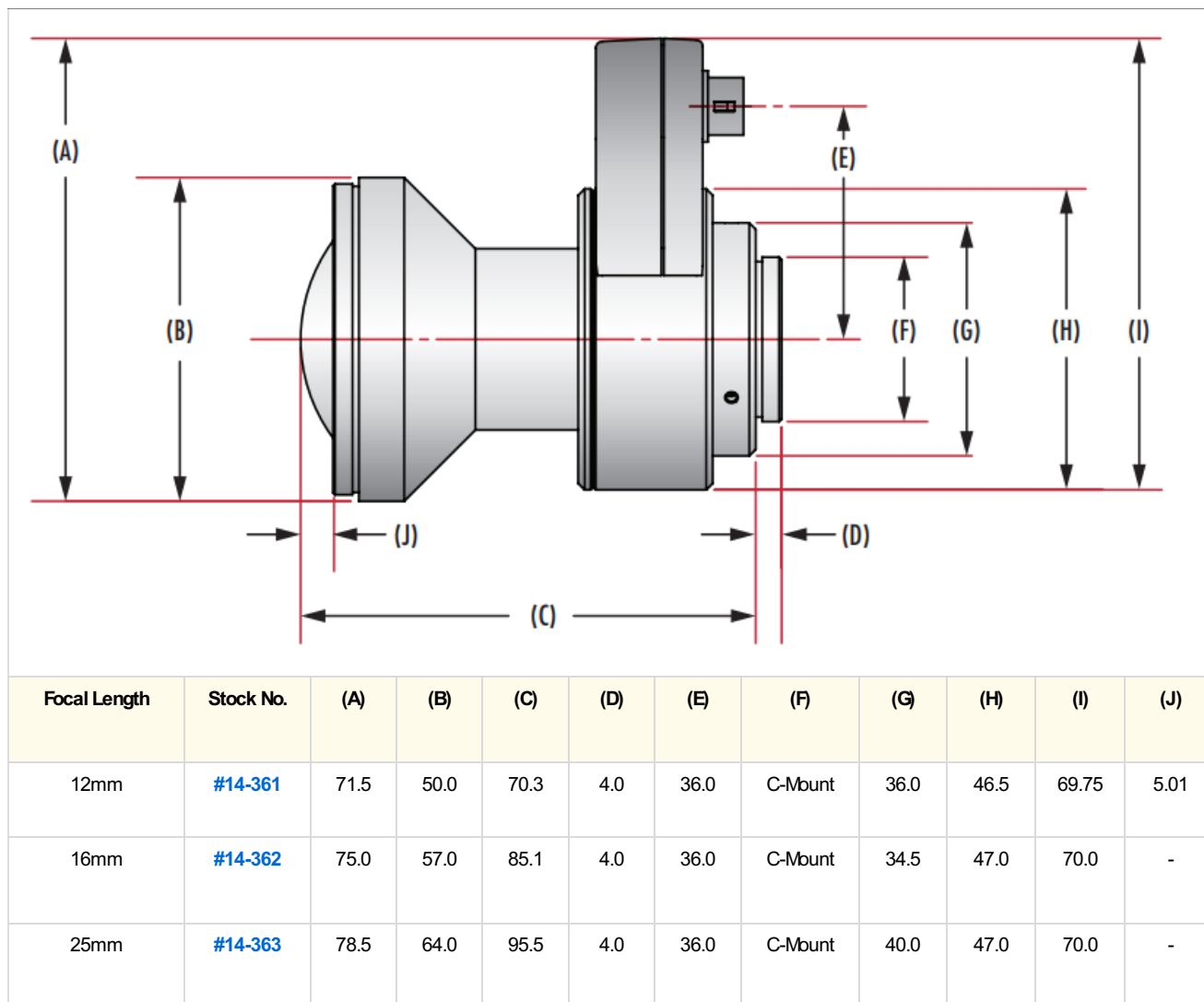

Compatible Cameras