

[See all 195 Products in Family](#)

TECHSPEC® 12.7mm Dia. x 75mm FL, 1064nm Coated, Laser Grade PCX Lens



TECHSPEC Laser Grade PCXLenses

Stock **#38-736** **16 In Stock**

[Other Coating Options](#)

⊖ 1 ⊕ **\$291⁰⁰**

ADD TO CART

Volume Pricing	
Qty 1-5	\$291.20 each
Qty 6-25	\$232.40 each
Qty 26-49	\$214.20 each
Need More?	Request Quote

Product Downloads

General

Plano-Convex Lens **Type:**

Physical & Mechanical Properties

12.70 +0.00/-0.025 **Diameter (mm):**

Centering (arcmin):

<1

Center Thickness CT (mm):
4.00 ±0.10

Edge Thickness ET (mm):
3.43

Clear Aperture CA (mm):
11.43

Bevel:
Protective as needed

Optical Properties

Effective Focal Length EFL (mm):
75.00 @ 355nm

Back Focal Length BFL (mm):
72.31

Coating:
Laser V-Coat (1064nm)

Coating Specification:
 $R_{\text{abs}} < 0.25\%$ @ 1064nm

Substrate:
Fused Silica (Corning 7980)

Surface Quality:
10-5

Power (P-V) @ 632.8nm:
 λ

Irregularity (P-V) @ 632.8nm:
 $\lambda/10$

Focal Length Tolerance (%):
 ± 1

Radius R_1 (mm):
35.71

f#:
5.91

Numerical Aperture NA:
0.08

Design Wavelength DWL (nm):
1064

Damage Threshold, By Design:
 15 J/cm^2 @ 1064nm, 20ns, 20Hz

Regulatory Compliance

Certificate of Conformance:
[View](#)

Need different specs or modifications?

Edmund Optics offers comprehensive custom manufacturing services for optical and imaging components tailored to your specific application requirements. Whether in the prototyping phase or preparing for full-scale production, we provide flexible solutions to meet your needs. Our experienced engineers are here to assist—from concept to completion.

Our capabilities include:

- Custom dimensions, materials, coatings, and more
- High-precision surface quality and flatness
- Tight tolerances and complex geometries
- Scalable production—from prototype to volume

Learn more about our [custom manufacturing capabilities](#) or submit an inquiry [here](#).

Product Details

- Guaranteed Laser Damage Threshold
- 10-5 Surface Quality
- $\lambda/10$ Surface Accuracy

TECHSPEC® Laser Grade PCX Lenses are designed for high energy Nd:YAG laser applications including laser cutting, machining, and welding. The precision fused silica substrate, featuring $\lambda/10$ surface accuracy and 10-5 surface quality, ensures low scatter and excellent transmitted wavefront performance. TECHSPEC® Laser Grade PCX Lenses are available uncoated or with a variety of high laser damage threshold anti-reflection (AR) coating options. Coatings are available at the most common Nd:YAG laser wavelengths to ensure maximum laser throughput.

LASER OPTICS MADE BY EDMUND OPTICS®

[LEARN MORE](#)

532nm V-Coat
 $R_{(obs)} < 0.25\% @ 532nm$

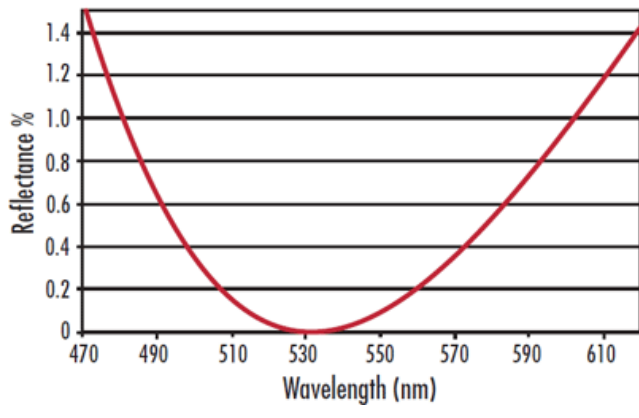

355nm V-Coat
 $R_{(obs)} < 0.25\% @ 355nm$

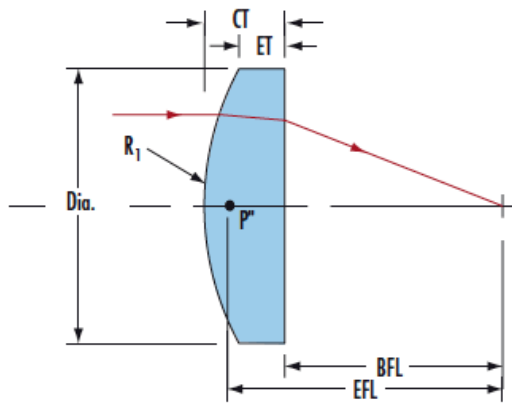
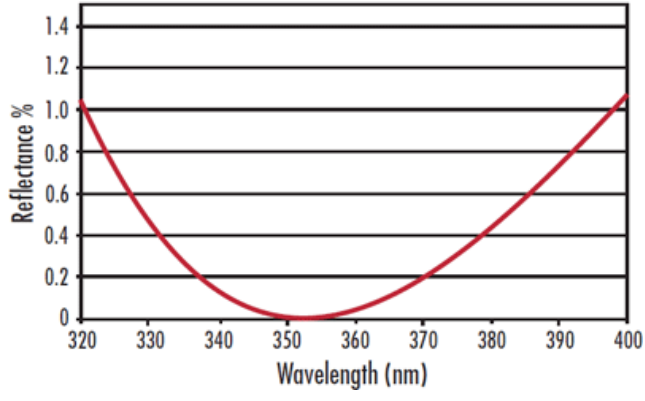

1064nm V-Coat
 $R_{(obs)} < 0.25\% @ 1064nm$

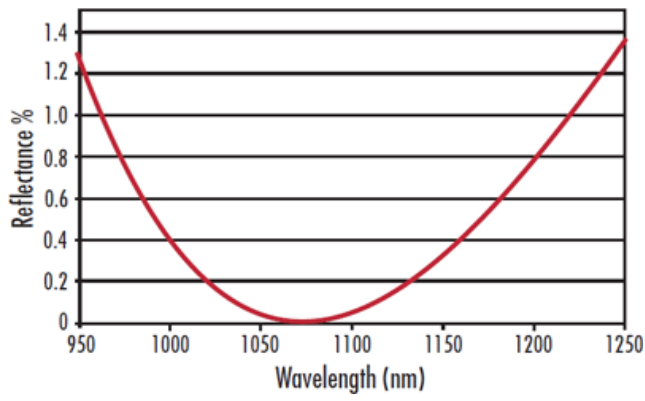

Compatible Mounts