

TECHSPEC® 12.5mm FL f/4, Blue Series M12 Lens



12.5mm FL Blue Series M12 Lens



Stock #69-264 **20+ In Stock**

S\$119.⁰⁰

ADD TO CART

Volume Pricing

Qty 1-49	S\$119.00 each
Qty 50+	S\$94.00 each
Need More?	Request Quote

Product Downloads

General

Blue Series **Product Family:**

M12 Imaging Lens **Type:**

No **IR Cut Filter:**

Imaging Lens Type:

High Performance M12 Lens

Physical & Mechanical Properties**Iris Option:**

Fixed

Length (mm):

22.90

Maximum Diameter (mm):

15

Outer Diameter (mm):

15

Weight (g):

6

Optical Properties**Horizontal Field of View @ Max Sensor Format:**
28.9°**Field of View at Max Sensor Format:**

Horizontal: 78.1mm - 28.9°

Vertical: 58.5mm - 21.8°

Diagonal: 97.7mm - 35.7°

Horizontal Field of View, 1/2" Sensor:

78.0mm - 28.8°

Horizontal Field of View, 1/2.5" Sensor:

70.6mm - 26.2°

Horizontal Field of View, 1/3" Sensor:

58.4mm - 21.8°

Horizontal Field of View, 1/4" Sensor:

43.8mm - 16.4°

Maximum Image Circle (mm):

8.00

Numerical Aperture NA, Object Side:

0.0095

Number of Elements (Groups):

5(5)

Wavelength Range (nm):

400 - 700

Focal Length FL (mm):

12.50

Working Distance (mm):

150 - ∞

Aperture (f/#):

f/4

Distortion (%):

-0.36 @ Full Field

Back Focal Length BFL (mm):

10.1 - 9.7

Coating Specification:M4 MgF₂ @ 550nm**Entrance Pupil Position (mm):**

10.87

Object Space Principal Plane (mm):

10.14

Image Space Principal Plane (mm):

-3.01

Maximum Distortion (%):

-0.36

Exit Pupil Position (mm):

-2.33

Lens Wavelength Range:

VIS

Sensor**Maximum Sensor Format:**

1/2"

Pixel Size (μm):

1.40

Threading & Mounting**Filter Thread:**

N/A

Mount:

S-Mount (M12 x 0.5)

Regulatory Compliance

Compliant

RoHS 2015:

[View](#)

Certificate of Conformance:

Compliant

Reach 247:

Product Details

- Up to 1/2", S-Mount Lens
- Up to 5 MegaPixels, 1.4µm Pixel Size Sensors
- High Resolution Board Camera Lens Optimized for Close WD
- 2mm to 35mm Focal Length
- **Ruggedized Designs** Also Available

TECHSPEC® Blue Series M12 Lenses feature high resolution performance, along with the same great versatility of our [TECHSPEC® Green Series M12 Lenses](#). Each lens consists of several precision glass elements mounted in a compact, aluminum housing. These lenses can connect to C-Mount cameras using the M12 x0.5 Adapter for C-Mount Cameras ([#53-675](#)) or the M12 x0.5 C-Mount Adapter with Rubber O-Ring ([#59-241](#)) for vibration-sensitive environments. TECHSPEC® Blue Series M12 Lenses are ideal for automotive, industrial, and medical imaging application. Prescription data is available by submitting a [Request for Prescription Form](#).

Note: Compatible [TECHSPEC® M12 Imaging Lens Accessories](#) available.

Edmund Optics has created multiple product families of our TECHSPEC® M12 S-Mount Lenses, which are designed to provide high resolution. These high performance lenses feature precision glass designs in a metal housing and have optimized specifications between each product family to meet your application needs.

- Blue Series M12 Lenses: High resolution finite conjugate designs optimized for machine vision working distances.
- **Rugged Blue Series M12 Lenses:** **Stabilized ruggedization** versions of our Blue Series M12 Lenses, utilizing the same optics.
- **Green Series M12 Lenses:** Finite conjugate designs optimized for machine vision working distances.
- **Red Series M12 Lenses:** Infinite conjugate designs optimized for high resolution performance out to infinity.
- **HEO Series M12 Lenses:** Harsh Environment Optics (HEO) sealed versions of our Red Series M12 Lenses.
- **Liquid Lens M12 Lenses:** Integrated liquid lens for fast electronic focus.

Technical Information

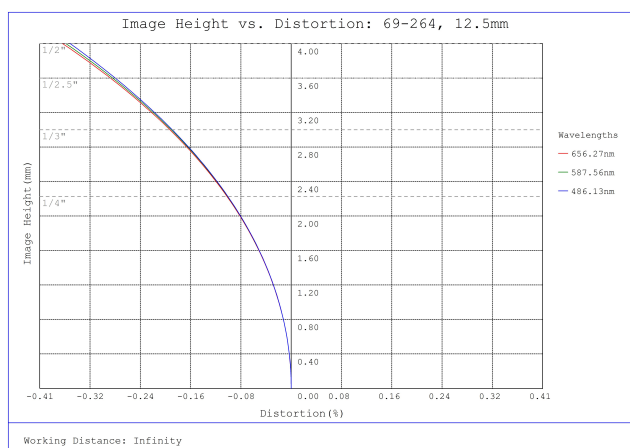

#69-264, 12.5mm FL f/4, Blue Series M12 Lens, Distortion Plot

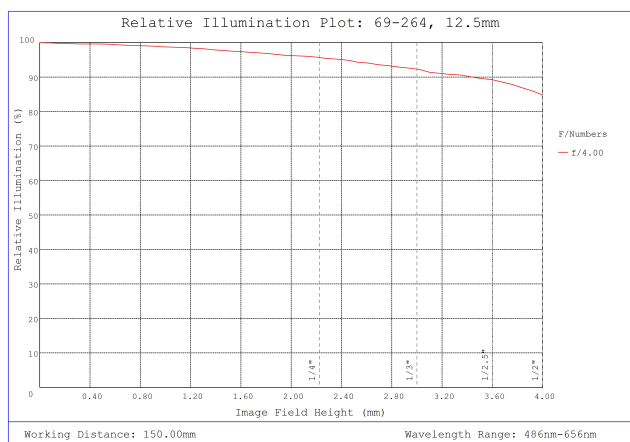

#69-264, 12.5mm FL f/4, Blue Series M12 Lens, Relative Illumination Plot

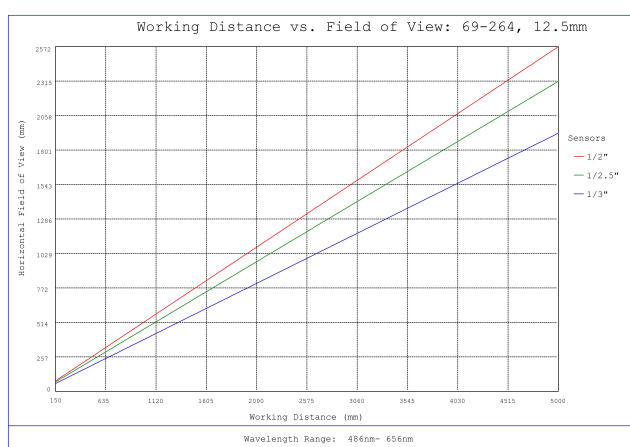

#69-264, 12.5mm FL f/4, Blue Series M12 Lens, Working Distance versus Field of View Plot

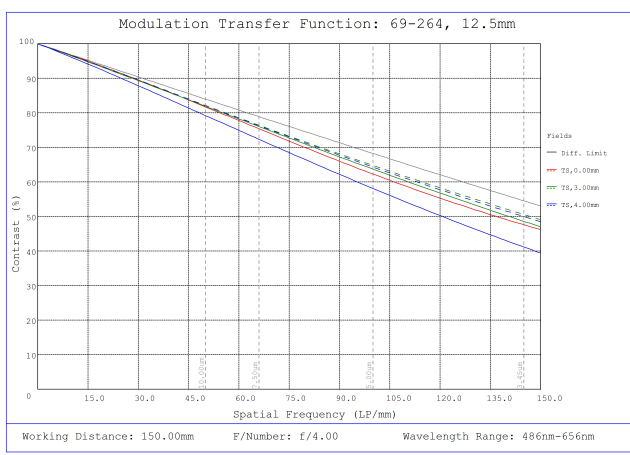

#69-264, 12.5mm FL f/4, Blue Series M12 Lens, Modulated Transfer Function (MTF) Plot, 150mm Working Distance, f4

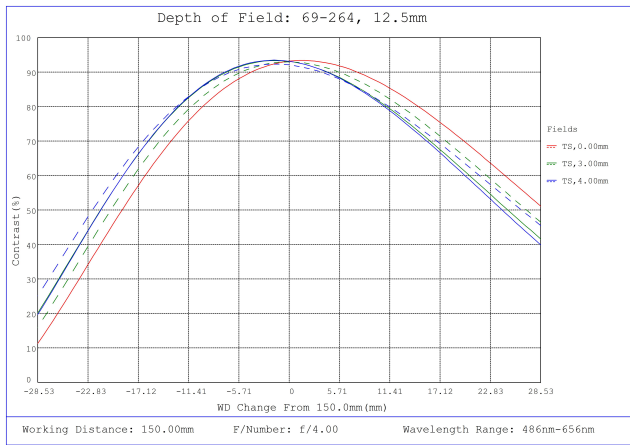

#69-264, 12.5mm FL f/4, Blue Series M12 Lens, Depth of Field Plot, 150mm Working Distance, f4

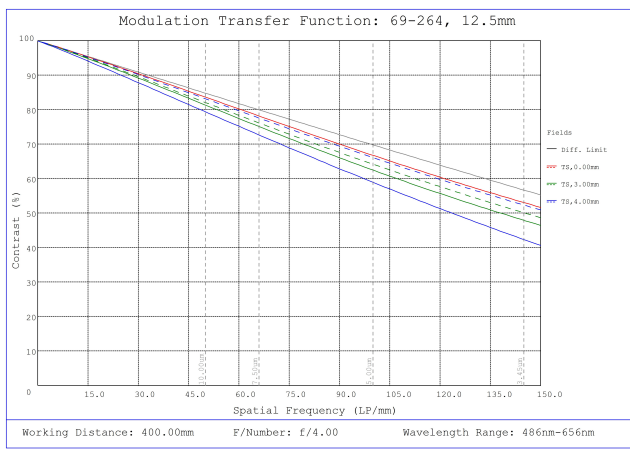

#69-264, 12.5mm FL f/4, Blue Series M12 Lens, Modulated Transfer Function (MTF) Plot, 400mm Working Distance, f4

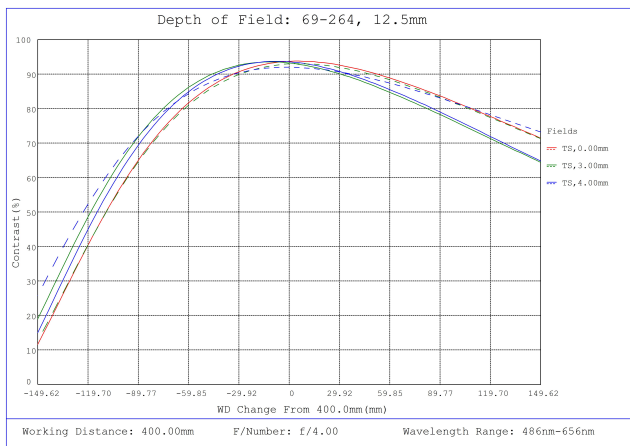

#69-264, 12.5mm FL f/4, Blue Series M12 Lens, Depth of Field Plot, 400mm Working Distance, f4

Focal Length	A	B	C*	D
2.0mm	18.0mm	21.7mm	2.26mm	4.75mm
3.0mm	14.0mm	17.1mm	4.8 - 4.7mm	5.8mm
4.0mm	14.0mm	19.7mm	6.1 - 6.0mm	4.4mm
5.0mm	14.0mm	14.6mm	4.0 - 3.9mm	3.7mm
6.0mm	14.0mm	14.1mm	6.9 - 6.8mm	4.5mm
8.0mm	14.0mm	12.3mm	8.8 - 8.6mm	3.7mm
10.0mm	14.0mm	17.0mm	6.6 - 6.3mm	3.7mm

12.5mm	15.0mm	22.9mm	10.1 - 9.7mm	4.8mm
17.5mm	14.0mm	20.7mm	5.8 - 4.9mm	7.6mm
25.0mm	18.0mm	30.0mm	8.5 - 6.5mm	11.5mm
35.0mm	18.0mm	29.5mm	18.72 - 14.0mm	14.5mm

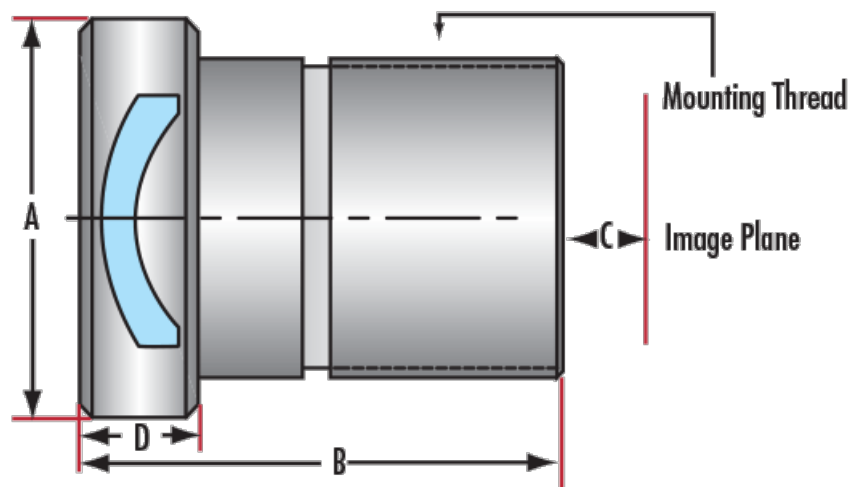

*Specified for Optimized Working Distance of 150 - 250mm.