

[See all 15 Products in Family](#)

TECHSPEC® 1064nm 1X - 3X Research-Grade Variable Beam Expander



Research-Grade Variable Beam Expanders



Stock **#87-562** **4 In Stock**

- 1 + **S\$1,720⁰⁰**

ADD TO CART

Volume Pricing	
Qty 1-4	S\$1,720.00 each
Qty 5-24	S\$1,522.00 each
Qty 25-99	S\$1,351.00 each
Need More?	Request Quote

Product Downloads

General

Beam Expander **Type:**

Variable Magnification **Style:**

Physical & Mechanical Properties

171.10	Length (mm):
556	Weight (g):
58.2	Housing Diameter (mm):

Optical Properties

10	Entrance Aperture (mm):
30	Exit Aperture (mm):
1X - 3X	Expansion Power:
Fused Silica (Coming 7980)	Substrate: <input type="checkbox"/>
>97.5 @DWL	Transmission (%):
0 ±0.06	Angle of Incidence (°):
Laser V-Coat (1064nm)	Coating:
1064	Design Wavelength DWL (nm):
<λ/7 @ 1064nm for Input Beam ≤5mm	Transmitted Wavefront, P-V:
1030 - 1100	Wavelength Range (nm):
R _{abs} <0.25% @ 1063 - 1065nm R _{avg} <0.5% @ 1030 - 1100nm	Coating Specification:
10 J/cm ² @ 10ns, 20 Hz, 1064nm	Damage Threshold, By Design: <input type="checkbox"/>
Non-Rotating Optics	Divergence Adjustment:
10 J/cm ² @ 1064nm, 10ns, 20Hz	Damage Threshold, Pulsed:

Threading & Mounting

Input: Male C-Thread (1" x 32 TPI) Output: Male T-Thread (M42 x 0.75)	Mounting Threads:
--	--------------------------

Regulatory Compliance

Compliant	RoHS 2015:
View	Certificate of Conformance:
Compliant	Reach 247:

Need different specs or modifications?

Edmund Optics offers comprehensive custom manufacturing services for optical and imaging components tailored to your specific application requirements. Whether in the prototyping phase or preparing for full-scale production, we provide flexible solutions to meet your needs. Our experienced engineers are here to assist—from concept to completion.

Our capabilities include:

- Custom dimensions, materials, coatings, and more
- High-precision surface quality and flatness
- Tight tolerances and complex geometries
- Scalable production—from prototype to volume

Learn more about our [custom manufacturing capabilities](#) or submit an inquiry [here](#).

Product Details

For optimal performance, center the laser beam to the entrance lens and ensure that the beam is parallel to the beam expander's optical axis.

- 1X–3X and 2X–8X Variable Magnification
- Non-Rotating Lenses Minimize Beam Wander
- Compact Galilean Designs with Fixed Housing Length
- **TECHSPEC® Draconis® Broadband Beam Expanders** Also Available

TECHSPEC® Research-Grade Variable Beam Expanders (RVBX) are ideal for high power laser applications where magnification changes may be required, such as prototyping or R&D. TECHSPEC Research-Grade Variable Beam Expanders feature λ/4 transmitted wavefront, Galilean designs, and high laser damage threshold AR coatings to ensure maximum transmittance while minimizing ghost reflections. Additionally, these beam expanders use internal translation and focusing mechanisms to variable adjust magnification and laser divergence without affecting overall housing length. This compact design removes the need to make system accommodations for changes in length and eases system integration.

TECHSPEC Research-Grade Variable Beam Expanders can be used to determine a system's required beam magnification in the prototyping phase of development. **TECHSPEC® Draconis® Broadband Beam Expanders** are available for production or OEM implementation. Please contact our [Sales Department](#) for custom magnification requirements.

Technical Information

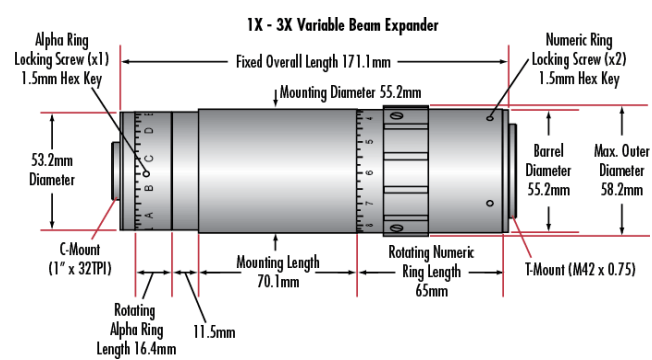

Design Wavelength	Stock No.	Fixed Overall Length A (mm)	Mounting Length E (mm)	Rotating Numeric Ring Length F (mm)	Rotating Alpha Ring Length G (mm)
355nm	#87-566	169.7	35.9	90.7	19.4
532nm	#87-567	169.3	31.5	70.4	43.7
Broadband VIS (633nm)	#87-569	169.3	31.5	70.4	43.7
Broadband NIR (785nm)	#87-570	169.3	31.5	70.4	43.7
1064nm	#87-568	169.3	31.5	70.4	43.7

2X - 8X Variable Beam Expander

